

D**CK****INDUSTRIES**



DOCK INDUSTRIES

OUR COMPANY

Dock Industries is proud to supply a full range of dock and marina supplies, all across Canada. All the products that we make and distribute have been created or chosen according to our best values :

*INTEGRITY

We stand behind our decisions. This value sets the way for all our professional and commercial practices. This leads us towards respect, honesty, transparency and equity.

*SERVICE

No matter if you are an international customer or a private individual, we love to know your projects and we will focus our energy to suggest you tips to make you save time and money to accomplish your project.

*QUALITY

We believe that quality is very important. We want our customers to use the best quality on the market to keep their investment last much longer without worries.



TABLE OF CONTENTS

DOCK HARDWARE

| | |
|---|---|
| PIPE & RESIDENTIAL FLOATING DOCK HARDWARE | 2 |
| HEAVY DUTY FLOATING DOCK HARDWARE | 2 |
| COMMERCIAL FLOATING DOCK HARDWARE | 3 |

PROTECTION

| | |
|-----------------------|---|
| PROTECTION "D" OR "P" | 4 |
| XL POSEIDON BUMPERS | 5 |
| DOCK CORNER | 5 |
| ELITE CORNER BUMPER | 6 |
| MANILA ROPE | 6 |
| TORPEDO PIPE BUMPERS | 7 |
| DOCK WHEELS | 7 |

EAGLE FLOATS

| | |
|------------------------------|---|
| EAGLE 24"X48"X12" DOCK FLOAT | 8 |
| EAGLE 36"X48"X12" DOCK FLOAT | 8 |
| EAGLE 48"X48"X12" DOCK FLOAT | 8 |
| EAGLE 48"X72"X12" DOCK FLOAT | 8 |
| EAGLE 36"X48"X16" DOCK FLOAT | 8 |
| EAGLE 24"X48"X16" DOCK FLOAT | 8 |
| EAGLE 48"X48"X16" DOCK FLOAT | 8 |
| EAGLE 48"X72"X16" DOCK FLOAT | 8 |
| SIZES | 9 |

DOCK & BOAT ACCESSORIES

| | |
|-----------------------|----|
| HEAVY DUTY DOCK CARTS | 10 |
| BOUY | 10 |

THRUFLOW

| | |
|----------|----|
| THRUFLOW | 11 |
|----------|----|

SOLAR LIGHTING

| | |
|----------------------|----|
| CLEATLITE™ | 12 |
| SOLAR SENTINEL™ | 12 |
| POSTLITE™ | 12 |
| HD ALUMINUM DOCKLITE | 13 |
| SOLAR DOTS | 13 |
| SIDE MOUNT LITE | 13 |

CLEATS

| | |
|---------------------------|----|
| FLIP-UP™ CLEATS | 14 |
| "S" CLEATS | 14 |
| OPEN BASE CLEATS | 14 |
| "T" ALUMINIUM CAST CLEATS | 15 |
| MOLDED CLEATS | 15 |
| CAST IRON CLEATS | 15 |

MOORING WHIPS

| | |
|-----------------------|----|
| PREMIUM MOORING WHIPS | 16 |
|-----------------------|----|

LADDERS

| | |
|------------------------|----|
| STAND OFF, ROTO-MOLDED | 17 |
| ALUMINIUM LADDER | 17 |

PWC PORT

| | |
|-------------|----|
| ROLL & RIDE | 18 |
|-------------|----|

DOCK WHEELS

| | |
|-------------------------------|----|
| DOCK AND BOAT LIFT 24" WHEELS | 19 |
| LEG PIPE SAND AUGER | 19 |

DIY FLOATING DOCK KIT

| | |
|----------------|----|
| DOCK KITS | 20 |
| HOW TO CHOOSE | 21 |
| STANDARD SIZES | 22 |

BUOYANCY

| | |
|----------|----|
| BUOYANCY | 24 |
|----------|----|



PIPE & RESIDENTIAL FLOATING DOCK HARDWARE

1/8" (nominal) Hot Dipped Galvanized Steel with 7/16" holes for 3/8" Carriage Bolts except where indicated.

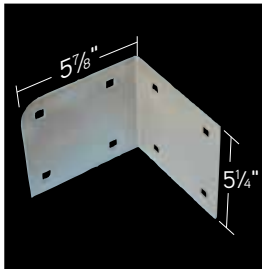

0001 Corner Plate.
Used on inside corners for increased strength.

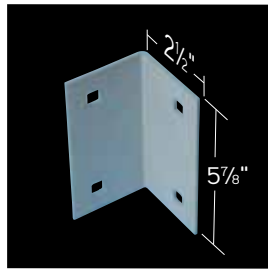

0002 Joist Corner.
Used to reinforce stringer joints.

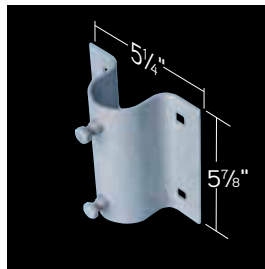

0005 Side Leg Holder.
Can be mounted inside or outside of the dock frame.

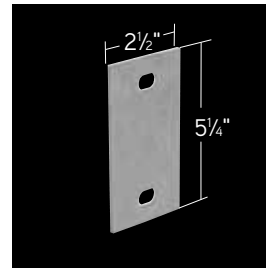

0003 Washer Plate.



0004 Connector Hinge.

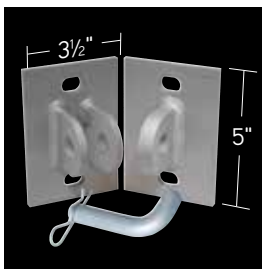

0007 Connector Hinge Kit.
3/16" thickness.

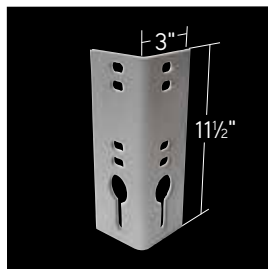

0008 Anchor Chain Corner.
3/16" thickness.
Universal hole placement.

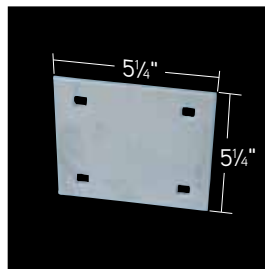

0010 Backer Plate.
Prevents pipe from deforming wood causing bolt loosening and dock shifting.

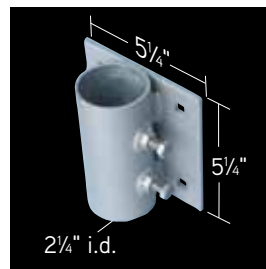

0011 HD Side Leg Holder,
Galvanized. Use inside or outside of dock frame.

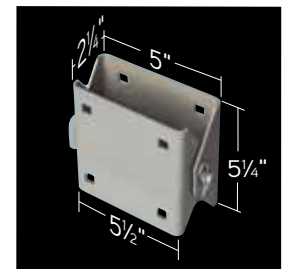

0012 Connector Hinge.
Used to join dock sections or a fixed ramp to the dock at varying angles. Includes hinge pin.

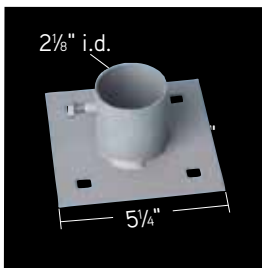

1107 Base Plate. Used as a footing. May be bolted to a 2" x 6" piece of lumber and joined to an adjacent base plate for stability.

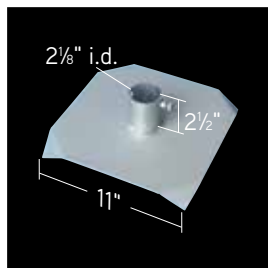

1108 Bottom Pad. Use for soft bottom applications. Allows leg pipe to extend through to lake bed for lateral support. Pointed corners.

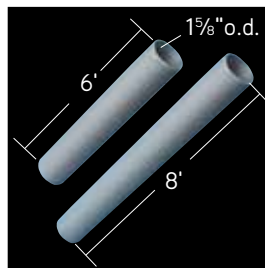

1111 (6') & 1112 (8') Galvanized Leg Pipe.



1115 Leg Cap. Use to cover raw leg pipe edges. Gives dock the finishing touch.

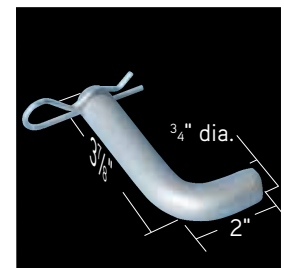

3313 Connector Pin used to join male and female connectors.

HEAVY DUTY FLOATING DOCK HARDWARE

- All Floating Dock Hardware is 5 Gauge (1/4" nominal). Hot Dipped Galvanized Steel with 3/8" hole punches on 3 1/2" centers except where indicated.
- Slot sizes are 3/8" x 1 1/8" except where indicated.
- All Male and Female Connectors have a 3/8" tab with a 7/8" hole to fit a 3/4" Pin or bolt.

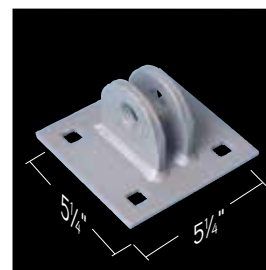

3306 Female T Connector.
See Male T Connector and Connector Pin.



3307 Male T Connector.
Use with all styles of Female Connector Hinges.

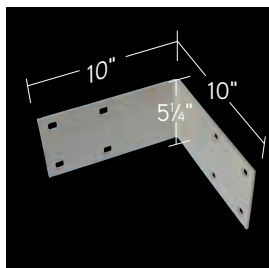

3008 Outside Corner. Use with backer plates or inside corners at outside ends of docks, fingers and swim platforms.

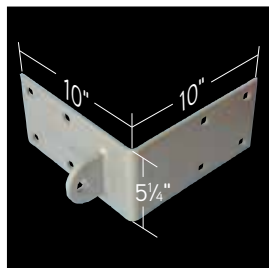

3009 Male Corner Hinge. Use with all styles of Female Connector Hinges.

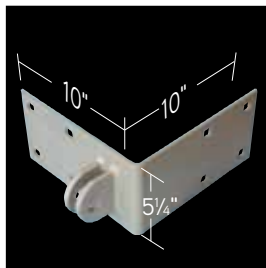

3010 Female Corner Hinge. See Male Corner Hinge.

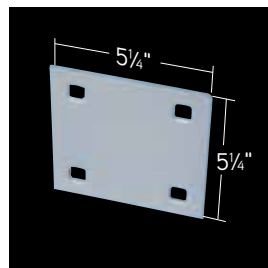

3300 Backer Plate. Used to sandwich wood framing when another piece of hardware isn't used. Prevents bolt loosening or pull-thru.

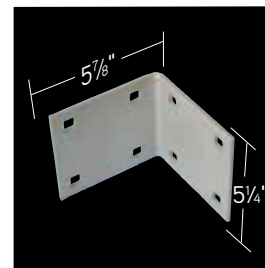

3305 Inside Corner. For lighter duty applications where an outside corner is not necessary.



30000 Chain Retainer. Holds chain up to 1/2" to secure the dock in position.

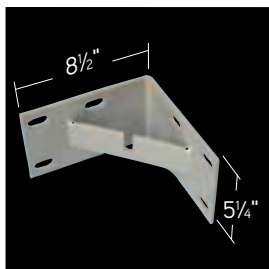

30030 HD Anchor Chain Corner. Offers maximum corner strength when used with 3008 Outside Corner or any Corner Connecting Hinge.

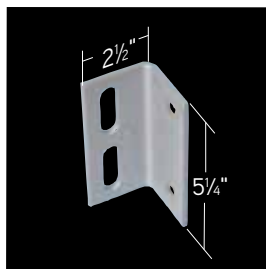

30040 Joist Corner. Use to mount stringers with 30050 washer plates. Also use as a backer plate to prevent cleats from pulling out.

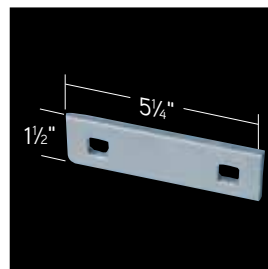

30050 Washer Plate.

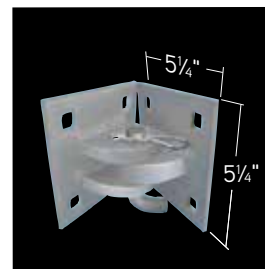

79-001 Connector Hinge T Style Backer Plate. HD with 1/2" & 3/4" tabs. Universal hole placement.



30020 Side Leg Holder, Galvanized. Free bolts.

COMMERCIAL FLOATING DOCK HARDWARE

- All Commercial dock hardware is 1/4" or 3/16" gauge, hot dipped galvanized with 9-16"x1" oblong Hole.
- Universal holes placement for best fitting with any 3-1/2", 4-1/2" & 5-1/2" CC hole backer plate.
- 3013 & 3015 are made to build up "skirt style" dock.

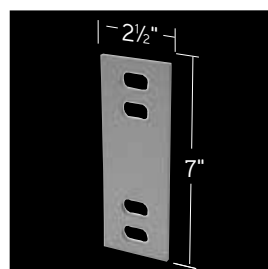

1102 Universal Plate for 2'x8' and Over. 3/16" thickness.

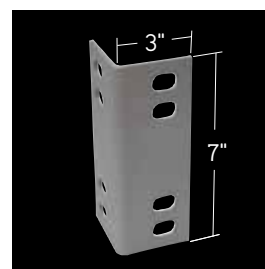

1101 Inside Corner. 3/16" thickness. Universal hole placement.

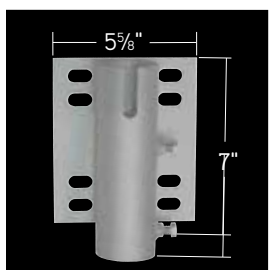

1104 Multi-Anchoring Leg Holder. 3/16" thickness. Universal hole placement.

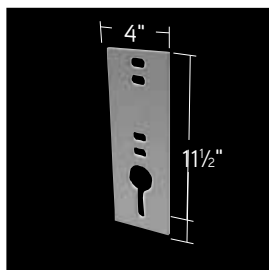

2003 Anchor Chain Plate. Universal hole placement.

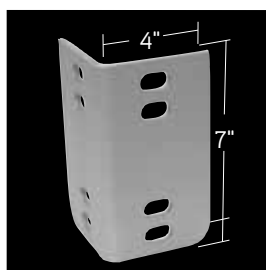

3012 Inside Corner. Universal hole placement.

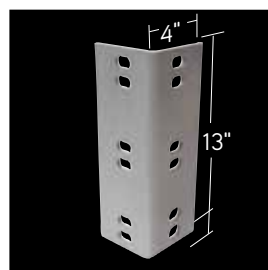

3013 Inside Corner. Universal hole placement.

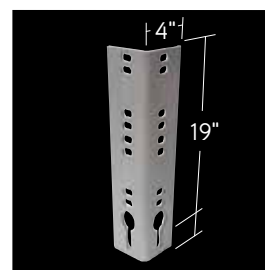

3015 Anchor Chain Corner. Universal hole placement.

QT: Use Backer Plates OR washer plates and sandwich lumber between hardware components with carriage bolts. Lag bolts for hardware will fail.



ALL Dock Industries Profiles have molded-in UV Inhibitors and Fungicides.

Our Commercial Profiles are the ultimate in Heavy-Duty cushioning and offer years of protection for your boat. Available in two different styles and colors with heavier walls and integrally molded ribs where desirable for superior strength and durability.

Commercial grade Heavy Duty vinyl profiles have a smooth high-gloss finish and are manufactured with 100% virgin material with UV Inhibitors and Fungicides.

Commercial Profiles will retain their resilience in all weather conditions and resist discoloration, mildew, salt water, hardening and tearing. Ideal for use in marinas and larger commercial applications.

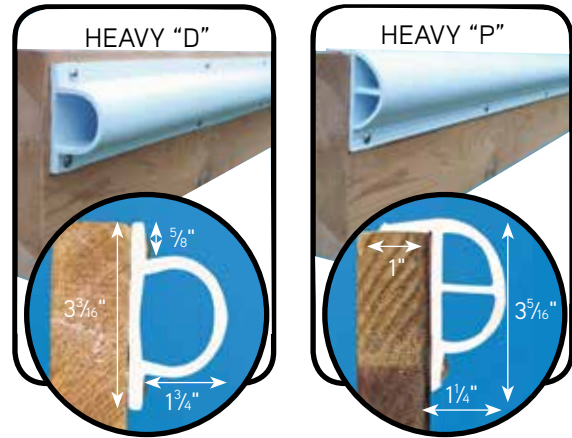

| TYPE | WHITE | BEIGE | BLACK | DESCRIPTION |
|-----------|--------|--------|--------|----------------------|
| HEAVY "D" | 5016BL | 5016BE | 5016NR | 8ft strip- 6pcs/ box |
| HEAVY "P" | 5015BL | 5015BE | 5015NR | 8ft strip- 6pcs/ box |

ALL Dock Industries + Standard PVC Profiles have molded-in UV Inhibitors and Fungicides.

Perfect profiles for small outboards or personal watercraft, these Standard PVC Profiles can be installed in minutes and will retain resiliency and brilliance for years. Each Profile provides a large contact area for added protection, combined with resiliency and durability.

The versatile Standard "D" profile without a lip can be mounted vertically or horizontally anywhere on the dock face. Great for pilings too. Extruded from Marine Grade PVC with UV Inhibitors and Fungicides.

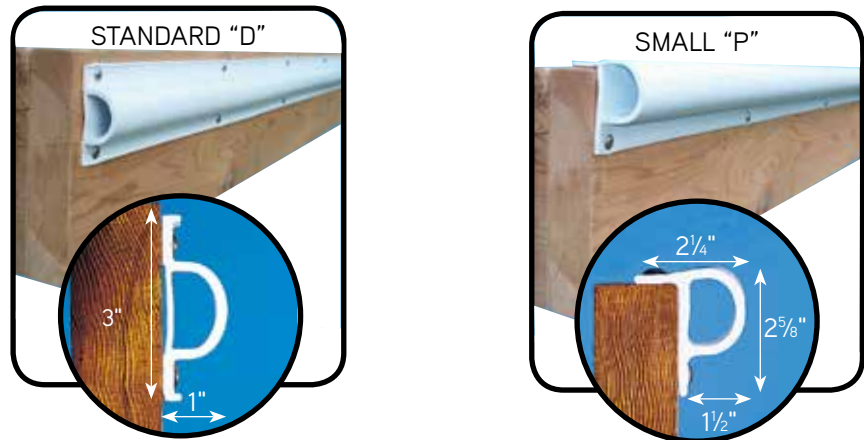

| WHITE | BEIGE | BLACK | DESCRIPTION |
|--------|--------|--------|-----------------|
| 5017BL | 5017BE | 5017NR | 16' (4,9m) Roll |

| WHITE | BEIGE | BLACK | DESCRIPTION |
|--------|--------|--------|-----------------|
| 5018BL | 5018BE | 5018NR | 16' (4,9m) Roll |

- QT: Having a partner to aid in positioning your profiles during installation will help to ensure it is secure and straight.
- QT: Keep your dock bumper profiles looking new. Wipe with a marine vinyl cleaner several times through the season.



XL POSEIDON BUMPERS

These Heavy Duty roto-molded bumpers' incorporate all the benefits of a multi-usage product with the strength and integrity you've come to know from Dock Industries+ products. Due to its' design it will not only protect the lower bow but anywhere you install an XL POSEIDON BUMPERS.

Fabricated to be permanently secured in place, it also has grooves which act as reinforcing ribs and can be used for temporary strapping in places where fastening isn't allowed. Ideal for commercial & marina applications.

Fabricated with UV Inhibitors and Fungicides. Includes screw-in inflation valve.



| WHITE | NAVY BLUE | BLACK | DESCRIPTION |
|-------|-----------|-------|------------------------|
| 5013W | 5013N | 5013B | PARE-CHOCS XL POSEIDON |



DOCK CORNER

This roto-molded bumper is fabricated from soft vinyl with UV Inhibitors and Fungicides. Each piece has angled ends to deflect craft and molded-in ribs for additional strength. The contours of each piece protects above as well as the dock face, providing excellent gunnel protection for bass and ski boats. Mounts easily in minutes and is suitable for all applications.

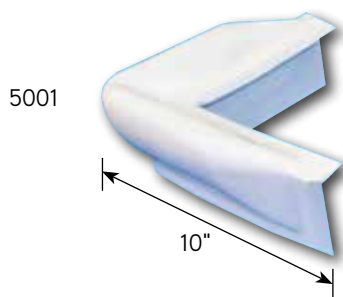

5002

| WHITE | BLACK | BEIGE | DESCRIPTION |
|-------|-------|-------|---------------------------------|
| 5001 | 5002 | 5003 | 10" (24.4cm) Corner Bumper only |

QT: Use a deep driver bit when installing screws in recessed bosses to ensure sufficient tightening strength.



ELITE CORNER BUMPERS

Protect your vessel from damaging impact by using premium dock corners. This air-filled bumper is constructed from PVC with UV Inhibitors and Fungicides. Features a built-in air valve for inflation or deflation if necessary.

| WHITE | BEIGE | BLACK |
|-------|-------|-------|
| 5004 | 5005 | 5006 |

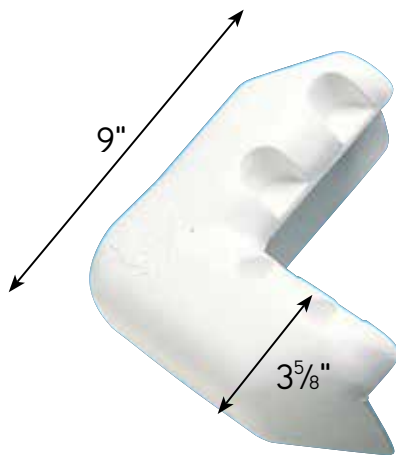

MANILA ROPE

| PART # | DESCRIPTION |
|--------|-------------|
| 1120 | 1" OD |
| 1121 | 1-1/2" OD |



QT: Your dock can look this good too. Dock Industries has everything you need to make your dream dock a reality.

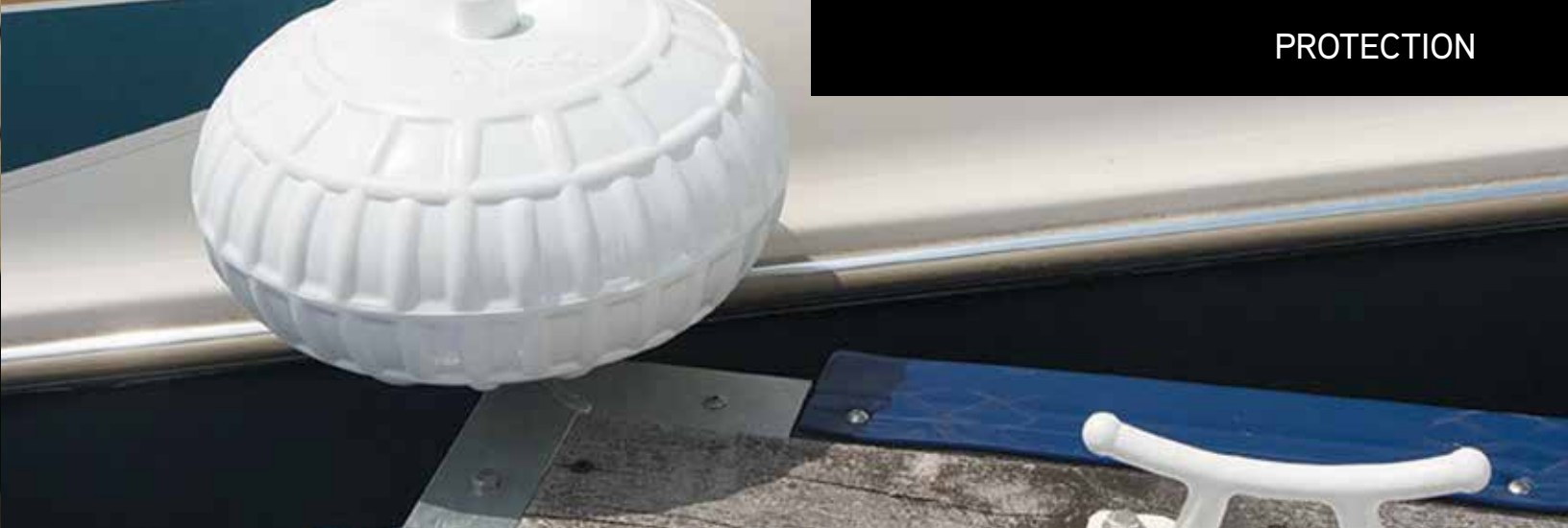

TORPEDO PIPE BUMPERS

These large, durable bumpers add an attractive and functionally rugged cushion to the leg pipes of your docking system. Fabricated from the same quality material as our fenders, each measures 18" (45,7cm) tall with a diameter of 5" (12,7cm). Each torpedo bumper also includes a molded-in air valve for easy inflation or deflation as desired. When placed over dock leg pipes and mounting brackets, they prevent damage to your craft from protruding bolts. Designed to fit pipe up to 2" (5,1cm) O.D.

| WHITE | BEIGE | BLACK | DESCRIPTION |
|-------|-------|-------|--------------------------------|
| 5008 | 5009 | 5010 | 5" (12,7cm) Dia., 18" (45,7cm) |

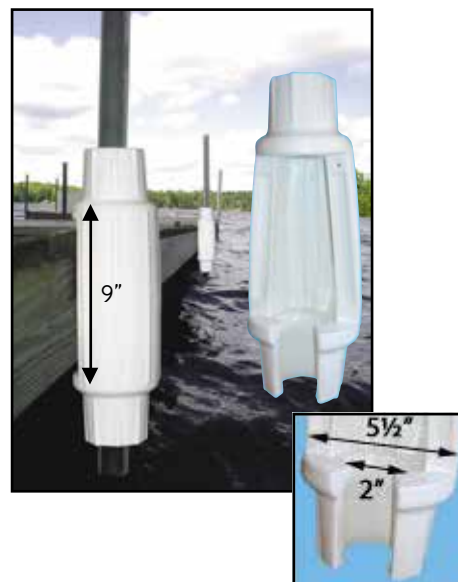

DOCK WHEELS

Smooth rolling wheels offer substantial dock cushioning and feature molded-in valves to adjust the level of firmness. Heavy-duty Hot Dipped galvanized hardware mounts securely to the dock. Guides boats into your slip easily, regardless of wind and current conditions.

Integrally molded ribs both top and bottom of these wheels makes them valuable dock and boat protection and formidable guards against impacts.

| PART # | DESCRIPTION |
|---------|-----------------------------|
| 5011-9 | 9" (22,9cm) Wheel, 1/ Ctn |
| 5011-12 | 12" (30,5cm) Wheel, 1/ Ctn |
| 5011-18 | 18" (45.7 cm) Wheel, 1/Ctn |

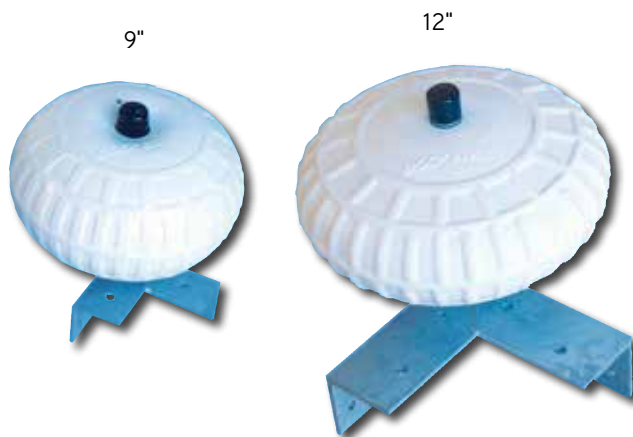

QT: Smooth rolling dock wheels effortlessly guide and protect your boat when docking, especially with novice captains at the helm.



Rotationally molded floats can be used on existing docks to gain freeboard, eliminate twisting, and/or improve the levelness of the dock. They can also be utilized in new construction of timber or truss dock systems. Eagle Floats are rotationally molded from the highest impact strength resin available containing UV inhibitors and carbon black pigment to protect against ultraviolet deterioration. These resins offer a balance of toughness, rigidity, environmental stress crack resistance and low temperature impact performance on all our **100+ sizes!**

Highlights that set our floats apart:

- Exceeds all USACE requirements
- InfraRed Thermometry (IRT) used to ensure precision floats every time
- Destructive and/or non-destructive tests conducted every day to ensure production consistency: wall thickness, wall strength, EPS foam flexural strength, EPS core density, and water absorption. (See brochure for results)
- In-house computer aided design for high quality and custom production options
- In-house tooling for low up-front costs and custom production options
- 15-year warranty with 10 years of non-prorated (100%) Coverage

Exceeds all 3rd party testing including but not limited to:

- The "Seven Day Hunt Absorption Test"
- Puncture testing (As per D4833-00e1-Standard Test Method of Index Puncture Resistance of Geotextiles, Geomembranes, and Related Products)
- Thickness Verification Test (as conducted by AmericanUE)

EAGLE 24"X48"X12" DOCK FLOAT

The Eagle 24" x 48" x 12" (61 x 121,9 x 30,5cm) has a floatation capacity (buoyancy) of 380 lbs (172,4 kg).

| PART # | DESCRIPTION |
|--------|-------------------|
| C2412 | 24"x48"x12" Float |



EAGLE 24"X48"X16" DOCK FLOAT

The Eagle 24" x 48" x 16" (61 x 121,9 x 40,6cm) has a floatation capacity (buoyancy) of 540 lbs (244,9 kg).

| PART # | DESCRIPTION |
|--------|-------------------|
| C2416 | 24"x48"x16" Float |



EAGLE 36"X48"X16" DOCK FLOAT

The Eagle 36" x 48" x 16" (91,4 x 121,9 x 40,6cm) has a floatation capacity (buoyancy) of 918 lbs (416,4 kg).

| PART # | DESCRIPTION |
|--------|-------------------|
| C3416 | 36"x48"x16" Float |



EAGLE 36"X48"X12" DOCK FLOAT

The Eagle 36" x 48" x 12" (91,4 x 121,9 x 30,5cm) has a floatation capacity (buoyancy) of 610 lbs (276,7 kg).

| PART # | DESCRIPTION |
|--------|-------------------|
| C3412 | 36"x48"x12" Float |



EAGLE 48"X48"X16" DOCK FLOAT

The Eagle 48" x 48" x 16" (121,9 x 121,9 x 40,6cm) has a floatation capacity (buoyancy) of 1219 lbs (552,9 kg).

| PART # | DESCRIPTION |
|--------|-------------------|
| C4416 | 48"x48"x16" Float |



EAGLE 48"X48"X12" DOCK FLOAT

The Eagle 48" x 48" x 12" (121,9 x 121,9 x 30,5cm) has a floatation capacity (buoyancy) of 830 lbs (376,5 kg).

| PART # | DESCRIPTION |
|--------|-------------------|
| C4412 | 48"x48"x12" Float |



EAGLE 48"X72"X12" DOCK FLOAT

The Eagle 48" x 72" x 12" (121,9 x 182,9 x 30,5cm) has a floatation capacity (buoyancy) of 1290 lbs (585,1 kg).

| PART # | DESCRIPTION |
|--------|-------------------|
| C4612 | 48"x72"x12" Float |



EAGLE 48"X72"X16" DOCK FLOAT

The Eagle 48" x 72" x 16" (121,9 x 182,9 x 40,6cm) has a floatation capacity (buoyancy) of 1780 lbs (807,4 kg).

| PART # | DESCRIPTION |
|--------|-------------------|
| C4616 | 48"x72"x16" Float |



More than 100 Standard Sizes!

| SIZE | TL QTY | BUOYANCY |
|--------------------------|--------|----------|
| 8" EAGLE FLOATS | | |
| 2436-08 | 768 | 205 |
| 2448-08 | 624 | 280 |
| 3648-08 | 408 | 450 |
| 10" EAGLE FLOATS | | |
| 2096-10 | 315 | 690 |
| 12" EAGLE FLOATS | | |
| 1636-12 | 800 | 190 |
| 2436-12 | 544 | 310 |
| 2448-12 | 416 | 380 |
| 2460-12 | 320 | 480 |
| 2496-12 | 208 | 880 |
| 3648-12 | 272 | 610 |
| 3048-12 | 336 | 540 |
| 3636-12 | 288 | 495 |
| 3660-12 | 216 | 750 |
| 3672-12 | 168 | 920 |
| 3696-12 | 136 | 1230 |
| 4848-12 | 208 | 830 |
| 4860-12 | 160 | 1060 |
| 4872-12 | 136 | 1290 |
| 4896-12 | 104 | 1680 |
| 16" EAGLES FLOATS | | |
| 1872-16 | 256 | 640 |
| 2436-16 | 408 | 390 |
| 2448-16 | 312 | 540 |
| 2460-16 | 246 | 680 |
| 3636-16 | 240 | 620 |
| 3648-16 | 204 | 890 |
| 3660-16 | 116 | 995 |

| SIZE | TL QTY | BUOYANCY |
|-----------------------------|--------|----------|
| 18" EAGLE FLOATS | | |
| 2448-18 | 260 | 620 |
| 3648-18 | 170 | 970 |
| FLANGED EAGLE FLOATS | | |
| 2448-08 | 624 | 240 |
| 2436-12 | 544 | 240 |
| 2448-12 | 416 | 360 |
| 2436-16 | 408 | 390 |
| 2448-16 | 312 | 480 |
| 3648-16 | 204 | 750 |
| 4848-16 | 156 | 1060 |
| 4672-16 | 102 | 1250 |
| 4872-16 | 260 | 1420 |
| 2448-18 | 260 | 530 |
| 3648-18 | 170 | 870 |
| 2448-20 | 360 | 600 |
| 3648-20 | 170 | 960 |
| 4848-20 | 120 | 1330 |
| 3648-24 | 136 | 1140 |
| 4848-24 | 104 | 1540 |
| 20" EAGLE FLOATS | | |
| 1248-20 | 520 | 300 |
| 2448-20 | 260 | 670 |
| 3648-20 | 170 | 1050 |
| 3660-20 | 100 | 1250 |
| 3672-20 | 101 | 1550 |
| 3696-20 | 85 | 2080 |

* Some size need a special order.

| SIZE | TL QTY | BUOYANCY |
|---------------------------|--------|----------|
| 20" EAGLE FLOATS | | |
| 1872-24 | 166 | 950 |
| 2448-24 | 208 | 800 |
| 3648-24 | 136 | 1230 |
| 3672-24 | 92 | 1850 |
| 3696-24 | 68 | 2480 |
| 4848-24 | 104 | 1680 |
| 4860-24 | 80 | 2080 |
| 4872-24 | 68 | 2540 |
| 4896-24 | 52 | 3550 |
| 28" EAGLE FLOATS | | |
| 3636-28 | 96 | 1030 |
| 3648-28 | 102 | 1375 |
| 4848-28 | 102 | 1800 |
| 2496-28 | 78 | 1930 |
| 3672-28 | 66 | 2150 |
| 3696-28 | 66 | 2880 |
| 4872-28 | 52 | 3070 |
| 4896-28 | 44 | 4090 |
| 32" EAGLE FLOATS | | |
| 3648-32 | 102 | 1610 |
| 3672-32 | 51 | 2490 |
| 3696-38 | 51 | 3260 |
| 4848-38 | 78 | 2180 |
| 4872-38 | 51 | 3320 |
| 4896-38 | 39 | 4470 |
| 36" EAGLE FLOATS | | |
| 2448-36 | 156 | 1150 |
| 3696-36 | 51 | 3610 |
| 4848-36 | 78 | 2450 |
| 4872-36 | 51 | 3770 |
| 4896-36 | 39 | 5050 |
| 10 FT EAGLE FLOATS | | |
| 36120-20 | 50 | 2350 |
| 48120-20 | 50 | 3800 |



HEAVY DUTY DOCK CART

- Zinc coated Steel Frame
- 20" wheel on sealed bearing
- No-flat solid polyurethane tire
- Polyethylene tub
- 400 lbs capacity



| PART # | DESCRIPTION |
|--------|-----------------|
| 4001 | Heavy Duty Cart |



BUOY

Our regulatory buoy shell is made out of heavy wall UV polyethylene, foam filled and concrete ballast. Recessed stainless steel eyebolt at bottom of buoy, imbedded in internal concrete base, & rope hole for use un marking swim areas.

An approved regulatory decal will be needed



| PART # | DESCRIPTION |
|--------|---------------------|
| 4011 | Yellow 16" diameter |
| 4012 | Red 8"OD x 13"L |
| 4015 | White 9"OD x 69.5"H |
| 4016 | Green 10"OD x 39"H |
| 4017 | Red 10"OD x 39"H |

Our 16" yellow polyethylene buoy is perfect to indicate any danger below surface of water that can't be seen. Integrated loop to fix chain and hardware.



Our polyethylene 8" red buoy is dedicated to fun. Use it to trace circuit for your favorite water sport. Integrated loop to fix chain and hardware.



QT: Contact us for all regulatory buoy decals available.



ThruFlow

The complete flooring system for Docks, Decks, Marinas, Gangways & Walkways. Easy to Assemble, Maintenance-Free & Long-Lasting!

ThruFlow™ is designed and engineered to be the finished decking surface for docks, decks, walkways and virtually any indoor or outdoor structure.

ThruFlow™ Panels are the ideal choice for:
Docks & Piers, Decks & Patios, Marinas, Walkways, Gangways & Ramps, any area prone to storm effects, or environmental sensitivity.



ADVANTAGES

The ThruFlow™ decking system offers a number of advantages over traditional decking. ThruFlow™ is a STRONG, DURABLE and LIGHTWEIGHT application for docks, decks, ramps and walkways.

- NO Maintenance
- Helps MINIMIZE Storm Surge and Wave Effects
- Stays COOL Even in the Hot Summer Sun
- UV and Static Electricity PROTECTION • SUPERIOR Load Bearing Capability
- 360° NON-SLIP Surface
- Available in 3, 4 and 5 foot lengths
- EASY Installation - NO DRILLING REQUIRED
- ALLOWS Sunlight, Water and Debris Through
- ACOE Approved & ADA Compliant
- Reduces snow maintenance
- Low environmental impact





CLEATLITE™

These solar lights are mounted on top of a sturdy galvanized steel base, housed inside an attractive, Colonial style 12" (30,5cm) tall, 4" (10,2cm) wide vinyl pillar. Easy to install and NO WIRES. These decorative and functional dock accessories will add style to your dock day or night. The lamp is designed to illuminate your boat, dock and stainless steel cleat, and not shine in your eyes.

Each kit includes, pillar, stainless steel cleat, galvanized mounting base, solar light and replaceable rechargeable batteries.

| PART # | DESCRIPTION |
|--------|-----------------------|
| 8010 | CleatLite™ - 1Pc/ Ctn |



SOLAR SENTINEL™

The Solar Sentinel™ is a solar station, which is not only attractive but also adds value and function to your docking area. Each Solar Sentinel™ incorporates stylish, durable solar lighting on an attractive, broad-based, tapered pillar to illuminate docking areas. The Solar Sentinel™ also has the capability of acting as a Life Ring station. The optional Stainless Steel "J" hook can securely keep a Life Ring at the ready and under the convenient illumination of the Solar Sentinel™ by day or through the darkest hours of night. Includes solar light, tapered pillar and replaceable rechargeable batteries. 40 lumens of emitted light.

| PART # | DESCRIPTION |
|--------|--|
| 8000 | Solar Sentinel, 35" (88,9cm), Includes solar light |
| 80003 | "J" Hook, Stainless Steel, Optional |



POSTLITE™

Install literally in minutes with NO WIRES. Powerful solar charging capacity with 360° light diffusing Polycarbonate lens and convex interior reflector maximize light output. Each PostLite™ fits post sizes: 1½" (4,1cm), 1⅞" (4,8cm), 2⅜" (6,0cm) O.D., and 3¼" (8,3cm) I.D. as well as flat surfaces with the INCLUDED adaptors.

6 PreInstalled LED colors and convenient touchpad built right into the circuit board means you can change colors to match a particular color scheme or merely differentiate your dock from your neighbors. NO LED swapping necessary to determine polarity or color output.

Rechargeable replaceable batteries included and concealed securely under the circuit board. 10 lumens of emitted light.

| PART # | DESCRIPTION |
|--------|---------------------|
| 8009 | PostLite™ - 2Pc/ Pk |





SOLAR PANORAMIC LED LIGHT

- Perfect for docks and decks
- Automatic on-at-dusk
- Weatherproof, durable
- Works 8 hours on a full charge
- Replaceable, rechargeable battery
- 4-5 lumens (emitted light)
- Size: 5" L x 4.25" W x 1" H
- Lumens: 5
- LEDs: 4



| PART # | DESCRIPTION |
|--------|------------------------------|
| 8011 | HD Aluminum DockLite, 1Pc/Pk |

SOLAR POST & SURFACE MOUNT LIGHT WITH MOTION SENSOR

- Stainless steel light mounts on posts or any vertical service
- Powerful solar charging performance
- Up to 3 meters and 90° detection angle vertically and horizontally
- White LED illuminates for 15 seconds when motion is detected
- Blue LED illuminates in standby
- Replaceable, rechargeable battery
- 40 lumens (emitted light)



| PART # | DESCRIPTION |
|--------|-------------------------|
| 8013 | Side Mount Lite, 1Pc/Pk |

SOLAR DOTS

Solar Dock Dots are neatest, smallest solar lights you have ever seen! A nearly flush mount makes them virtually unnoticeable during the day and eliminates any tripping hazards. Easy to install in minutes with a 1-3/8" drill bit. A super bright LED and powerful solar panel provide impressive nighttime illumination.

- Automatic on-at dusk
- Fresh and salt water rated
- 6-10 Hour Run Time
- Changeable Batteries
- 2-4 Lumens



| PART # | DESCRIPTION |
|--------|--------------|
| 8012 | "Solar Dots" |



QT: Always ensure that solar lighting is installed no less than 6ft. (2m) apart to prevent one solar light affecting another's performance.



FLIP-UP™ CLEATS

Cast from solid Marine Grade Almag 35 aluminum and powder coated white or burnished using a special process to give a traditional metallic finish. Distinctive and highly functional, they are available in 3 sizes to suit any requirement. Packaged 1 piece per bag with header card.

| WHITE # | BLACK # | POLISHED # | DESCRIPTION |
|---------|---------|------------|-------------|
| 8001BL | 8001NR | 8001PL | 6" (16,5cm) |
| 800BL | 8000NR | 8000PL | 8" (21,6cm) |



"S" CLEATS

These cast aluminum cleats are sand blasted to give a clean grey matte finish. Each cleat is designed with an extra wide footprint for added strength. As well, each cleat has an enlarged counter-sunk hole for easy installation with a socket. Can be through bolted or lag bolted. Available in 3 sizes.

| PART # | DESCRIPTION |
|--------|--|
| 8025 | "S" Cleat, 9" (22,9cm), Cast Aluminum |
| 8026 | "S" Cleat, 11" (27,9cm), Cast Aluminum |
| 8027 | "S" Cleat, 13" (33,0cm), Cast Aluminum |

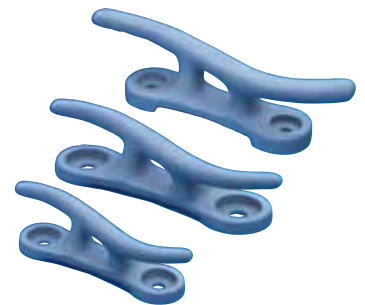

OPEN BASE CLEATS

These cast aluminum cleats are sand blasted to give a clean grey matte finish. Each cleat is designed with an extra wide footprint for added strength. As well, each cleat has an enlarged counter-sunk hole for easy installation with a socket. Can be through bolted or lag bolted. Available in four sizes.

| PART # | DESCRIPTION |
|--------|-----------------------------|
| 8028 | 6" (16,5cm) Open Base Cleat |
| 8029 | 8" (21,6cm) Open Base Cleat |



QT: Carriage or Thru-bolts are the most secure method of fastening cleats to your dock. Always fasten through into joists if using lag bolts.

"T" ALUMINIUM CAST CLEATS

Our T cleats are made from cast aluminium and then polished to give a uniform finish. Fit on any dock. Their conception is perfect to fit over aluminium dock profiles with a slot to be able to move them around effortlessly. (Bolts and nuts not included)

| PART # | DESCRIPTION |
|--------|--------------------|
| 8030 | 8" with 3/8" Holes |
| 8031 | 10" 1/2" holes |



CAST IRON CLEATS

These are your traditional, Cast Iron, Hot Dipped Galvanized Dock Cleats. The mounting holes are recessed with a hexagonal shape to stop the head of a carriage bolt from turning while securing the cleat to a surface. This eliminates the need for two wrenches when securing, or in some cases an extra pair of hands.

| PART # | DESCRIPTION |
|--------|------------------------------------|
| 8004 | 8" (20,3cm) Cast Iron, Galvanized |
| 8005 | 10" (25,4cm) Cast Iron, Galvanized |



MOLDED CLEATS

Injection molded High Density Polyethylene with U.V. Stabilizers. Attractive, functional, durable and will not chip or crack. 4 sizes available.

| PART # | DESCRIPTION |
|--------|-------------------------|
| 8006 | 8" (20,3cm) Black HDPE |
| 8007 | 10" (25,4cm) Black HDPE |



QT: Don't let just the size of your boat determine which cleat you use. Always consider wave and wake action that can increase cleat stress.

MOORING WHIPS



PREMIUM MOORING WHIPS

Exclusive “Plug & Socket” design for quick and easy separation, Tie-off cleat and NEW carbon fiber technology. Solid, cast aluminum base with built-in cleat, ring and thumb screw.

Unique tip with functional roller and a tie-off cleat for easier boat access. Simply release the whip line from the tie-off cleat. The whip lines effortlessly roll through the pulley at the tip causing the boat to gently approach the dock for boarding.

Patented cross-wound material. Double braided nylon whip lines, spring lines and unique line tensioner for one-handed set-up. Stainless steel mounting hardware included. Cast aluminum base with integral cleat and ring.

- 8' whips - 2 500 lbs max. craft weight
- 12' whips - 5 000 lbs max. craft weight
- 14' whips - 10 000 lbs max craft weight
- 16' whips - 20 000 lbs max craft weight



Set of two (2) whips includes

- Mooring lines
- Whip lines
- Tie-off cleats and aluminum tensioners.



SOLID CAST ALUMINUM BASE WITH BUILT-IN CLEAT & EYELET



CONVENIENT ROLLER TIP FOR EASE OF USE



ROLLER TIP PULLEY WHEEL



TIE-OFF CLEAT

| PART # | DESCRIPTION |
|--------|--|
| 8017 | Mooring Whip (Set of 2), 8' (2,4m) for craft up to 18' (5,5m) or 2,500 lbs (1134 kg) |
| 8018 | Mooring Whip (Set of 2), 12' (3,7m) for craft up to 23' (7m) or 5,000 lbs (2268 kg) |
| 8019 | Mooring Whip (Set of 2), 14' (4,3m) for craft up to 28' (8,5m) or 10,000 lbs (4536 kg) |

QT: If there is any question as to which whip size to use, it's best to go one size larger than question your decision later.



STAND OFF, ROTO MOLDED

Tough and Durable, this roto-molded ladder swings up and out the way, locking in place when not in use. Will not corrode with exposure and will not fade or crack. Molded-in U.V. Inhibitors and Fungicides. The Stand Off roto molded ladder extends into the water at a 60 degree angle to make getting out of the water easier. 500lbs (227kg) Capacity.

4 Steps, Polyethylene, Stainless Steel assembly hardware.

- Gable height : 20 1/2" (52.1cm)
- Distance to first step : 12 1/2" (31.8cm)
- Distance between treads : 10 1/2" (26.7cm)
- Tread Depth : 6 1/2" (16.5cm)
- Tread Width : 14" (35.6cm)

| PART # | DESCRIPTION |
|--------|--------------|
| 2084-F | 4 Step, Grey |



ALUMINIUM LADDER

This Ladder is manufactured with 1" heavy wall aluminum tubing. All assembly hardware is stainless steel and assembly is quick and easy. Simply tilt the ladder up and slide it out for storage and cleaning, or mount the ladder permanently with it's pre-drilled holes. 450 lbs (204 kg) Capacity.

- Rail Height : 24 1/2" (62,2cm) above the dock.
- Distance to first step : 12" (30,5cm)
- Distance between treads : 10 1/2" (26,7cm)
- Tread Depth : 4 3/4" (12,1cm)
- Tread Width : 15" (38,1cm)

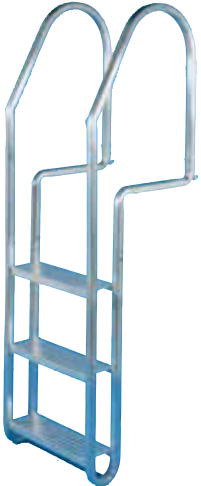

| PART # | DESCRIPTION |
|--------|------------------|
| 8014 | 3-Step, Complete |
| 8015 | 4-Step, Complete |
| 8016 | 5-Step, Complete |



QT: Never use any ladder for diving. Doing so may damage the ladder, void warranty and/ or result in personal injury.

PWC PORT



PWC PORT ROLL & RIDE

The most efficient on the market!
 For all PWC models. HDPE Rotomolded shell and EPS filled.

- 8 angles wheels to an easy landing without scratches
- Protect from moisture damage
- Adaptable to all kind of dock
- Easy installation
- No more cranking or lifting your PWC
- Jet float
- Double size available

Easy boarding and landing.



| SPECIFICATIONS | | | | |
|----------------|--------|--------|--------|----------|
| WIDHT | LENGHT | HEIGHT | WEIGHT | CAPACITY |
| 64" | 11' | 9" | 190lbs | 1400lbs |

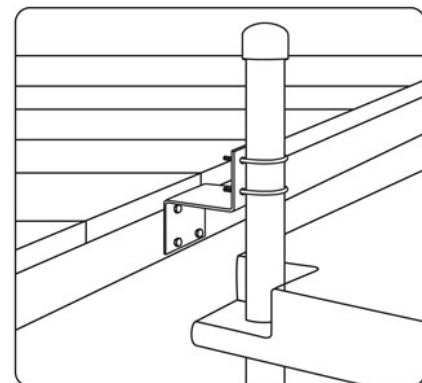

Z Braquets for installation



**3400 lbs rolling test

DOCK AND BOAT LIFT 24" WHEELS

Both our wheel have a diameter of 24" with a center hole that will accept a 1-7/8" axel.

Our 9001 is our heavy duty wheel that can support a impressive 1400 lbs charger per wheel, & 9002 standard wheel can support up to 700 lbs per wheel.

Take a look at our testing of 3400 lbs rolling test on 2 of our 9001 wheels. No crack or deformation were observe after a 8 hour shift

9004 This kit is to convert any floating dock into a rolling dock. Combine with our 9001 wheels, this will take even the heaviest wood floating dock. The brackets will fit over a 1-5/8" leg and is made for a 1-7/8" Axel.

9005 Transfer any aluminium or light weight pipe docks into a rolling dock in 5 minutes. Simply slide the brackets over your 1-5/8" pipes/legs, tight up the nuts on both sides, add nylon spacers, 24" wheel and finish with cutter pin. Envoy! (Wheels & 1-5/8" legs not included)



24"

| PART # | DESCRIPTION |
|--------|----------------------------|
| 9002 | 24" Dock Wheel, Standard |
| 9001 | 24" Dock Wheel, Heavy Duty |

9004



9001



9005

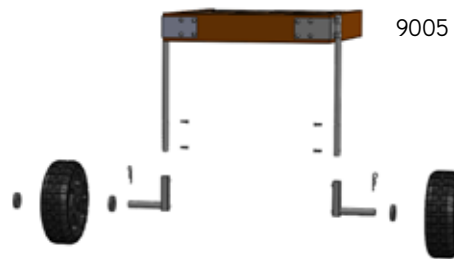

LEG PIPE SAND AUGER

Rugged Cast Iron auger fits up to 2" (5,1cm) O.D. pipe and easily penetrates sandy or soft sediment as well as packed surfaces.

Ideal for locations where it may be necessary to embed leg pipes deep into the lake bed for security.

| PART # | DESCRIPTION |
|--------|---------------------|
| 1106 | Leg Pipe Sand Auger |

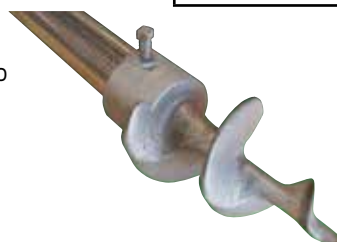



DOCK KITS

We have over 20 “DO IT YOURSELF” floating dock kits for your best applications divided in 3 categories.

Our kits are the most complete on the market

Material list & length for lumber is included for all our kits. (Lumber need to be purchased separately)

- Looking for a custom size, let us know, we will make it for you in the category you need

RESIDENTIAL (Small lake or gentle wave river and planning to dock canoe, kayak or small fishing boat)

To be built with 2”x6” lumber for frame with 5/4” deck board on top

- 12” high dock floats for lower freeboard
- Average of 25 lb of flotation per foot square
- Galvanized Hardware 1/8” thick
- 3/8” galvanized carriage bolts
- 1/2” pin dock connectors



HEAVY DUTY (Big lake, big river, even sea and planning to anchor up to 60’ boat)

**Make sure to have sufficient anchorage depending on size of boats!!

To be built with 2x6 but we suggest using 2’x8” for frame and 2x6” for decking

- 16” high dock floats for higher freeboard
- Average of 30 lb of flotation per foot square
- 1/4” thick Heavy Duty galvanized hardware
- 1/2”x3” galvanized carriage bolts
- 3/4” pin connectors



COMMERCIAL

For same applications as our Heavy duty kits but if you consider building frame with 2x10” or 2x12” for longer lifespan of your dock

- 16” high dock floats for higher freeboard
- Average of 30 lb of flotation per foot square
- 1/4” & 3/16” thick Commercial galvanized hardware
- 1/2”x3” galvanized carriage bolts
- 3/4” pin connectors



HOW KNOW WHICH CATEGORIE TO CHOOSE ?

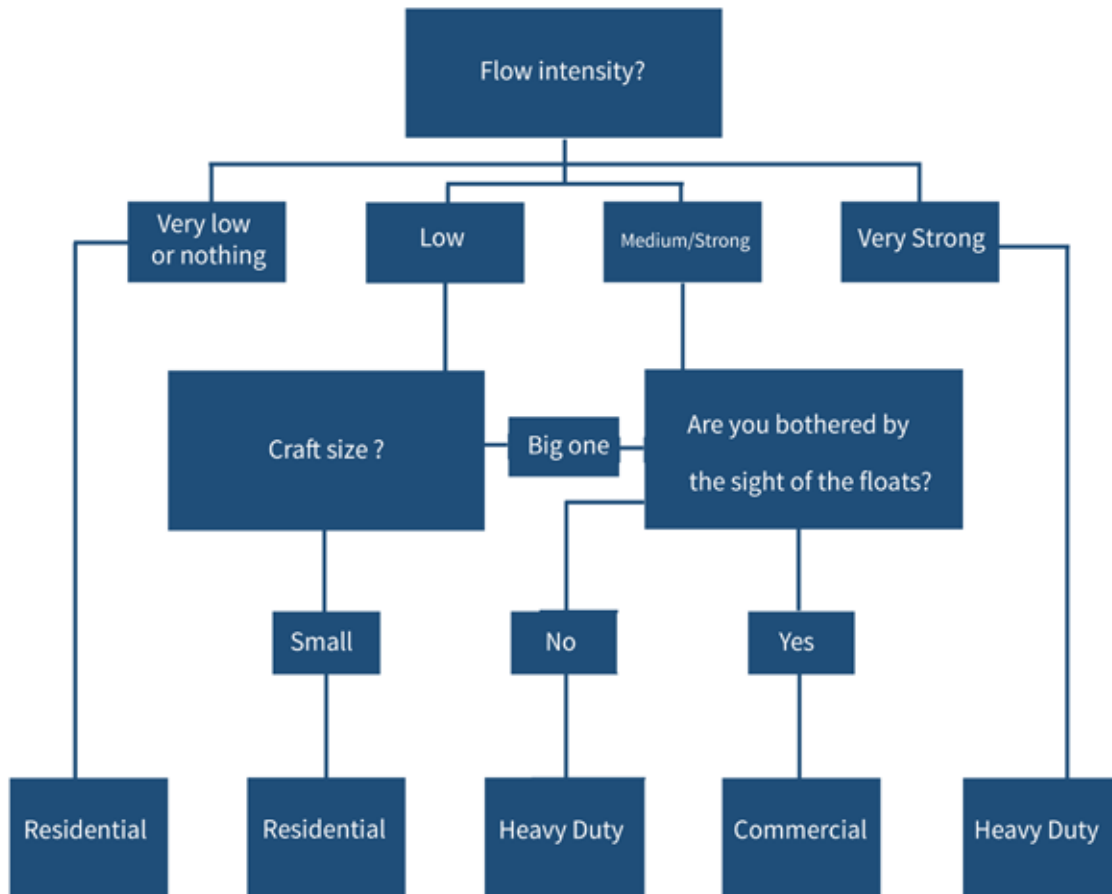





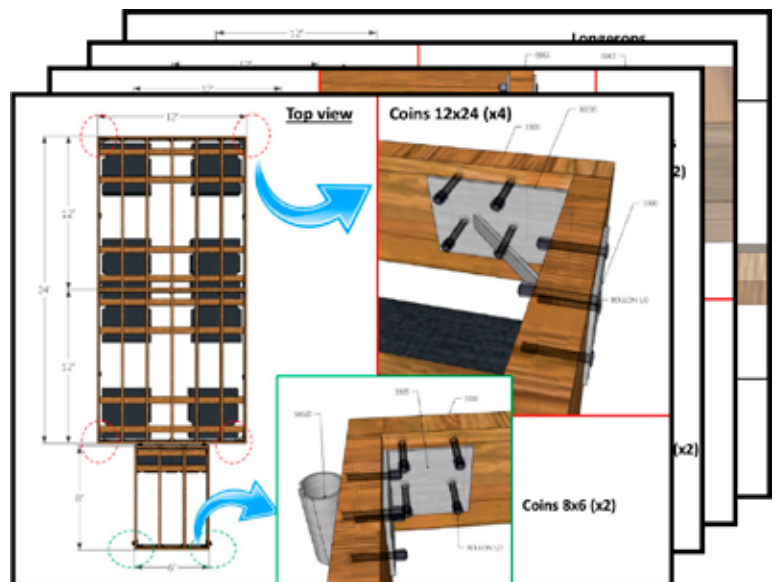



Our kits are the most complete on the market.
When you buy one you get :

- All hardware than you need
- Lumber length
- Installation plan (3D Sketchs).

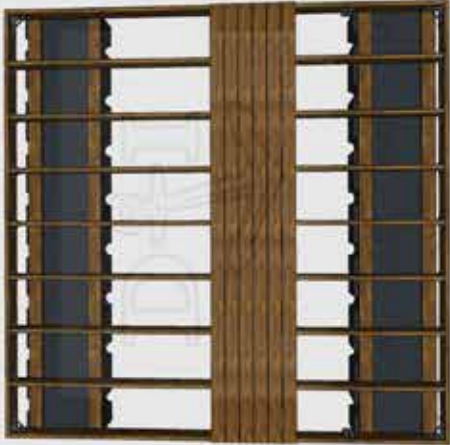
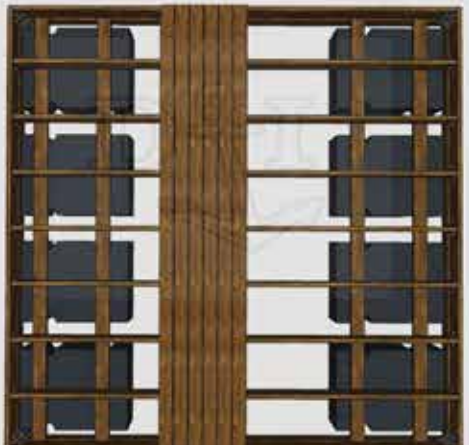

| Residential | Heavy Duty | Commercial |
|---|--|---|
|  |  |  |
|  |  |  |
| <p data-bbox="243 871 389 913"><u>4x16 SF</u></p> | <p data-bbox="690 871 901 913"><u>4x16 SF HD</u></p> | <p data-bbox="1274 1018 1307 1060">X</p> |
|  |  | |
| <p data-bbox="276 1176 389 1218"><u>6x16 R</u></p> | <p data-bbox="738 1176 885 1218"><u>6x16 HD</u></p> | <p data-bbox="1201 1176 1380 1218"><u>6x16 Com</u></p> |
|  |  |  |
| <p data-bbox="276 1554 389 1596"><u>8x12 R</u></p> | <p data-bbox="738 1554 885 1596"><u>8x12 HD</u></p> | <p data-bbox="1201 1554 1380 1596"><u>8x12 Com</u></p> |
|  |  |  |

| Residential | Heavy Duty | Commercial |
|--|--|--|
| <p data-bbox="272 260 391 302">8x16 R</p>  | <p data-bbox="735 260 886 302">8x16 HD</p>  | <p data-bbox="1198 260 1372 302">8x16 Com</p>  |
| <p data-bbox="266 569 397 611">10x16 R</p>  | <p data-bbox="727 569 894 611">10x16 HD</p>  | <p data-bbox="1190 569 1380 611">10x16 Com</p>  |
| <p data-bbox="266 947 397 989">12x16 R</p>  | <p data-bbox="727 947 894 989">12x16 HD</p>  | <p data-bbox="1190 947 1380 989">12x16 Com</p>  |
| <p data-bbox="315 1640 347 1682">X</p> | <p data-bbox="727 1409 894 1451">16x16 HD</p>  | <p data-bbox="1190 1409 1380 1451">16x16 Com</p>  |



| INCHES OUT OF WATER | INCHES OUT OF WATER | | | | | | INCHES OUT OF WATER | | | | | | INCHES OUT OF WATER | | | | | | | | | | | | | | |
|---------------------|---------------------|------|------|------|------|------|---------------------|------|----|----|---|---|---------------------|---|-----|----|----|----|----|----|----|----|----|---|---|---|---|
| | 6 | 4 | 2 | MAX | 20 | 18 | 16 | 14 | 12 | 10 | 8 | 6 | 4 | 2 | MAX | 24 | 22 | 20 | 18 | 16 | 14 | 12 | 10 | 8 | 6 | 4 | 2 |
| 08" | | | | | | | | | | | | | | | | | | | | | | | | | | | |
| 2072-08" | 40 | 130 | 240 | 350 | | | | | | | | | | | | | | | | | | | | | | | |
| 2448-08" | 60 | 130 | 210 | 290 | | | | | | | | | | | | | | | | | | | | | | | |
| 3648-08" | 80 | 210 | 310 | 460 | | | | | | | | | | | | | | | | | | | | | | | |
| 10" | | | | | | | | | | | | | | | | | | | | | | | | | | | |
| 2096-10" | 130 | 260 | 390 | 510 | 670 | | | | | | | | | | | | | | | | | | | | | | |
| 12" | | | | | | | | | | | | | | | | | | | | | | | | | | | |
| 1636-12" | 10 | 40 | 80 | 110 | 150 | 190 | | | | | | | | | | | | | | | | | | | | | |
| 3048-12" | 40 | 130 | 240 | 340 | 440 | 540 | | | | | | | | | | | | | | | | | | | | | |
| 2436-12" | 10 | 70 | 130 | 180 | 240 | 300 | | | | | | | | | | | | | | | | | | | | | |
| 2448-12" | 10 | 80 | 150 | 220 | 300 | 390 | | | | | | | | | | | | | | | | | | | | | |
| 2496-12" | 60 | 190 | 330 | 480 | 620 | 880 | | | | | | | | | | | | | | | | | | | | | |
| 3648-12" | 40 | 150 | 270 | 370 | 490 | 620 | | | | | | | | | | | | | | | | | | | | | |
| 3672-12" | 60 | 230 | 310 | 360 | 740 | 950 | | | | | | | | | | | | | | | | | | | | | |
| 3696-12" | 70 | 280 | 500 | 710 | 940 | 1250 | | | | | | | | | | | | | | | | | | | | | |
| 4848-12" | 70 | 220 | 370 | 530 | 680 | 850 | | | | | | | | | | | | | | | | | | | | | |
| 4860-12" | 70 | 260 | 450 | 640 | 830 | 1070 | | | | | | | | | | | | | | | | | | | | | |
| 4872-12" | 70 | 310 | 550 | 780 | 1000 | 1300 | | | | | | | | | | | | | | | | | | | | | |
| 4896-12" | 160 | 450 | 740 | 1040 | 1330 | 1750 | | | | | | | | | | | | | | | | | | | | | |
| 16" | | | | | | | | | | | | | | | | | | | | | | | | | | | |
| 1872-16" | 120 | 200 | 290 | 370 | 460 | 540 | 640 | | | | | | | | | | | | | | | | | | | | |
| 2436-16" | 70 | 120 | 170 | 220 | 270 | 320 | 390 | | | | | | | | | | | | | | | | | | | | |
| 2448-16" | 90 | 150 | 220 | 300 | 370 | 440 | 530 | | | | | | | | | | | | | | | | | | | | |
| 2460-16" | 110 | 200 | 290 | 380 | 470 | 560 | 670 | | | | | | | | | | | | | | | | | | | | |
| 3636-16" | 110 | 190 | 280 | 360 | 440 | 520 | 620 | | | | | | | | | | | | | | | | | | | | |
| 3648-16" | 140 | 250 | 360 | 470 | 580 | 700 | 820 | | | | | | | | | | | | | | | | | | | | |
| 3660-16" | 200 | 330 | 470 | 610 | 750 | 890 | 1050 | | | | | | | | | | | | | | | | | | | | |
| 3672-16" | 230 | 370 | 560 | 730 | 890 | 1070 | 1270 | | | | | | | | | | | | | | | | | | | | |
| 3696-16" | 310 | 530 | 750 | 970 | 1180 | 1400 | 1670 | | | | | | | | | | | | | | | | | | | | |
| 4848-16" | 200 | 360 | 510 | 660 | 820 | 970 | 1140 | | | | | | | | | | | | | | | | | | | | |
| 4860-16" | 260 | 440 | 630 | 820 | 1000 | 1180 | 1420 | | | | | | | | | | | | | | | | | | | | |
| 4872-16" | 300 | 530 | 760 | 990 | 1210 | 1450 | 1720 | | | | | | | | | | | | | | | | | | | | |
| 4896-16" | 450 | 740 | 1040 | 1340 | 1640 | 1940 | 2310 | | | | | | | | | | | | | | | | | | | | |
| 18" | | | | | | | | | | | | | | | | | | | | | | | | | | | |
| 2448-18" | 160 | 230 | 310 | 390 | 460 | 540 | 620 | | | | | | | | | | | | | | | | | | | | |
| 3648-18" | 260 | 380 | 490 | 600 | 720 | 830 | 960 | | | | | | | | | | | | | | | | | | | | |
| 20" | | | | | | | | | | | | | | | | | | | | | | | | | | | |
| 1248-20" | 60 | 90 | 130 | 160 | 190 | 230 | 260 | 310 | | | | | | | | | | | | | | | | | | | |
| 2448-20" | 160 | 230 | 300 | 370 | 440 | 520 | 590 | 680 | | | | | | | | | | | | | | | | | | | |
| ** 3636-20" | * | * | * | * | * | * | * | 764 | | | | | | | | | | | | | | | | | | | |
| 3648-20" | 250 | 370 | 480 | 590 | 690 | 800 | 920 | 1050 | | | | | | | | | | | | | | | | | | | |
| ** 3660-20" | * | * | * | * | * | * | * | 1310 | | | | | | | | | | | | | | | | | | | |
| 3672-20" | 370 | 540 | 710 | 880 | 1040 | 1220 | 1380 | 1580 | | | | | | | | | | | | | | | | | | | |
| 3696-20" | 490 | 710 | 920 | 1150 | 1360 | 1580 | 2080 | | | | | | | | | | | | | | | | | | | | |
| 4848-20" | 360 | 500 | 660 | 810 | 970 | 1110 | 1270 | 1430 | | | | | | | | | | | | | | | | | | | |
| 4860-20" | 420 | 600 | 800 | 980 | 1170 | 1370 | 1560 | 1750 | | | | | | | | | | | | | | | | | | | |
| 4872-20" | 560 | 780 | 1000 | 1230 | 1450 | 1660 | 1900 | 2120 | | | | | | | | | | | | | | | | | | | |
| 4896-20" | 790 | 1080 | 1390 | 1700 | 2000 | 2290 | 2600 | 2910 | | | | | | | | | | | | | | | | | | | |

Max values indicate the amount of weight required to submerge the entire float. Inches out of water allow you to calculate how much of the float will be exposed above water level with different amounts of weights atop the float. ** calculated Buoyancy

LIMITED WARRANTY INFORMATION – ALL PRODUCTS

Dock Industries warrants all products to be free of defects in workmanship and material for a period of two years (unless uniquely specified in one of the following paragraphs below) when used under normal conditions and for which use they are intended. Dock Industries shall not be liable for any incidental, consequential or special damages, without limitation any lost profits, business interruption, loss of opportunity or loss of revenue, resulting from the misuse of Dock Industries products and does not assume any liability of purchaser or others for injury to persons or property. Dock Industries makes no express or implied warranties other than the warranties set forth herein, including without limitation, the warranties of merchantability, fitness for a particular purpose, or from any trade usage.

Any defective product must be returned with a Return Goods Authorization # before being returned to Dock Industries. A copy of the original sales receipt, must accompany all claims. The freight on the defective goods is the responsibility of the consumer. Obligation under this warranty is limited to repair, replacement, or credit for the defective product, provided that Dock Industries determines that the product defect was not the result of misuse or neglect. Dock Industries will return the product repaired or replaced.

Some States and/or Provinces do not allow the limitation of incidental or consequential damages, or on the duration of an implied warranty so the above limitations or exclusions may not apply to you. This warranty may vary from State to State or Province to Province. This warranty gives you specific legal rights and you may also have other rights which vary from State to State or Province to Province.

To receive more information or to service the obligations under this warranty, contact Dock Industries at 1 877-564-7824 or at the following mailing address: Dock Industries • 8145 Boul. Industriel Chambly, Qc Canada J3L 5G8 • Website: www.dockindustries.com • Email: info@dockindustries.com

PROPRIETARY INFORMATION

This Dock Industries catalogue is provided for the use of Dock Industries customers, affiliates and associates. Dock Industries owns and retains the copyrights in the materials found in this catalogue. No one shall have the right to copy or republish in any form, any information found in this Dock Industries catalogue. No material from this Dock Industries catalogue may be copied, reproduced, republished, transmitted, or distributed, without the written consent of Dock Industries.

Dock Industries reserves the right to change or make alterations to any product in this catalogue by means of color and/or material without notice. We continually strive to provide our customers with innovative and Quality marine products. This may result in altering current product lines to accommodate those changes. Dock Industries makes no express warranties regarding the information provided in this catalogue.

Any dimensioned components in this catalogue may vary slightly by part or production cycle within a reasonable, acceptable Engineering allowance.



8145 Boul. Industriel Chambly, Qc Canada J3L 5G8
1 877-564-7824 | dockindustries.com